

virtuafit

Foldable TR-90i Treadmill

User manual



SAFETY INSTRUCTIONS	3 - 4
CHECKLIST	5
ASSEMBLY INSTRUCTIONS	6 - 10
FOLDING INSTRUCTIONS	11
MAINTENANCE	12 - 14
TROUBLE SHOOTING	15
CONTROL PANEL	16 - 24
APP INSTRUCTIONS	25
EXPLODED DRAWING	26
PARTS LIST	27 - 28
TRAINING INSTRUCTIONS	29

WARNING:

Before beginning any exercise program consult your physician. This is especially important for people who are over 35 years old or who have pre-existing health problems. Read all instructions before using any fitness equipment. Do not operate this device without properly fitted guards, as the moving parts can present a risk of serious injury if exposed.

ATTENTION

- It is important to read this entire manual before assembling and using the device. Safe and effective use can only be achieved if the device is assembled, maintained and used properly. It is your responsibility to ensure that all users of the device are informed of all warnings and precautions.
- Before starting any exercise program, you should consult your doctor to determine if you have any medical or physical conditions that could put your health and safety at risk, or prevent you from using the device properly. Your doctor's advice is essential if you are taking medication that affects your heart rate, blood pressure or cholesterol level.
- Be aware of your body's signals. Incorrect or excessive exercise can damage your health. Stop exercising if you experience any of the following symptoms: pain, tightness in your chest, irregular heartbeat, extreme shortness of breath, lightheadedness, dizziness or feelings of nausea. If you do experience any of these conditions you should consult your doctor before continuing with your exercise program.
- Keep children and pets away from the device. The device is designed for adult use only.
- Use the device on a solid, flat level surface with a protective cover for your floor or carpet. To ensure safety, the device should have at least 0.5 metres of free space all around it.
- Before using the device, check that the nuts and bolts are securely tightened.
- The safety of the device can only be maintained if it is regularly examined for damage and/or wear and tear.

- Always use the device as indicated. If you find any defective components while assembling or checking the device, or if you hear any unusual noises coming from the device during use, stop immediately. Do not use the device until the problem has been rectified.
- Wear suitable clothing while using the device. Avoid wearing loose clothing that may get caught in the device or that may restrict or prevent movement.
- The max user weight is 120 KGS. Braking ability is independent of speed.
- The device is not suitable for therapeutic use.
- Care must be taken when lifting or moving the device so as not to injure your back. Always use proper lifting techniques and/or seek assistance if necessary.
- Please keep the space at least 1 to 2 meter at the end of base frame to escape any accidents!
- Place the device on a clean and flat surface. Do not place the device on a thick carpet.
- The device is for indoor use and not for outdoor use to prevent damage. Keep the storage location dry, clean and flat. It is forbidden to use the device for purposes other than training.
- Only use the machine in an environment with an ambient temperature between 10 °C and 35 °C. Only store the device at an ambient temperature between 5 °C and 45 °C.

Warranty claim is excluded if the cause of the defect is the result of:

- Maintenance assembly and repair work not carried out by an official dealer.
- In the event of improper use, neglect and / or poor maintenance.
- Failure to maintain the device in accordance with the manufacturer's instructions (see the enclosed manual).

TOOLKIT

When you open the carton, and you will find the below parts in the carton:

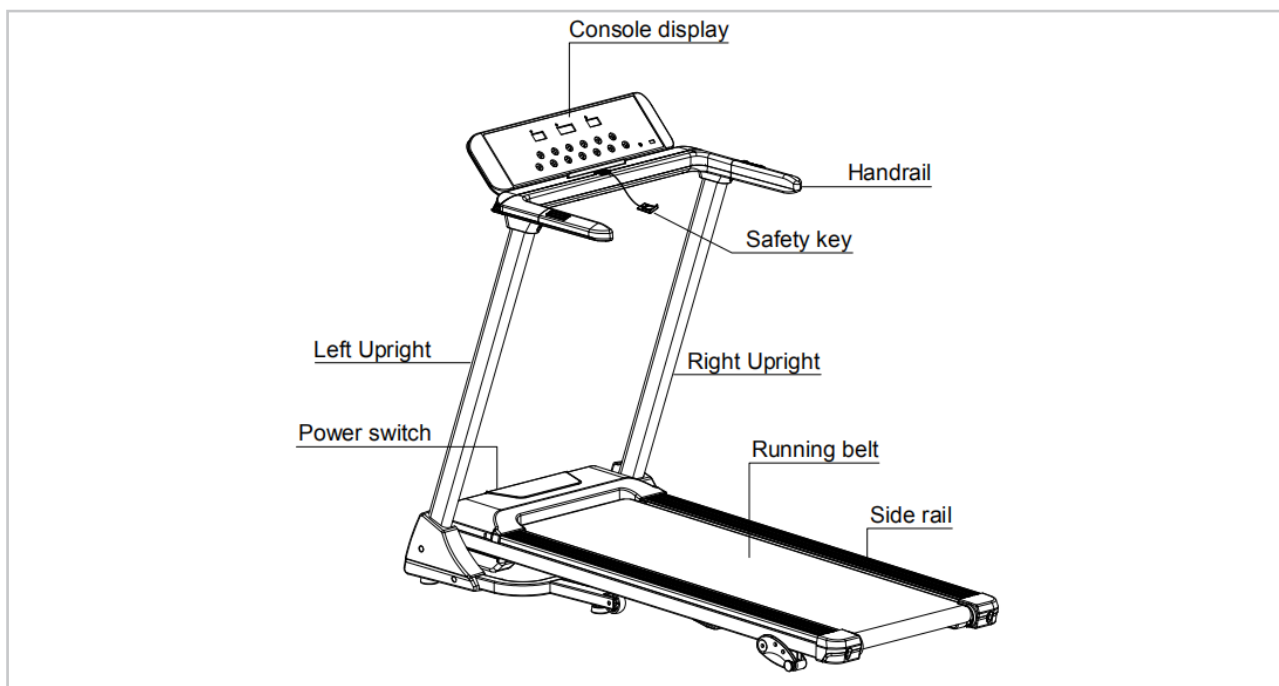

NOTE! Do not connect the appliance to the mains before it has been completely set up.

Missing parts: If you think you are missing certain parts in your package, carefully check the styrofoam and the device. Some parts (bolts, screws, etc.) are already attached to/in the device.

Error message: Ensure that all cables are carefully attached. The aluminum legs are very sensitive and must remain straight. Do you receive an error message after mounting your device? Then you have to straighten these aluminum legs again, this may cause the error message to disappear.

Socket screws: The device contains socket screws, make sure that the allen key is firmly in the bolt before you apply force to the key. In this way you prevent the head of the socket head screw from being rotated.

STEP 1

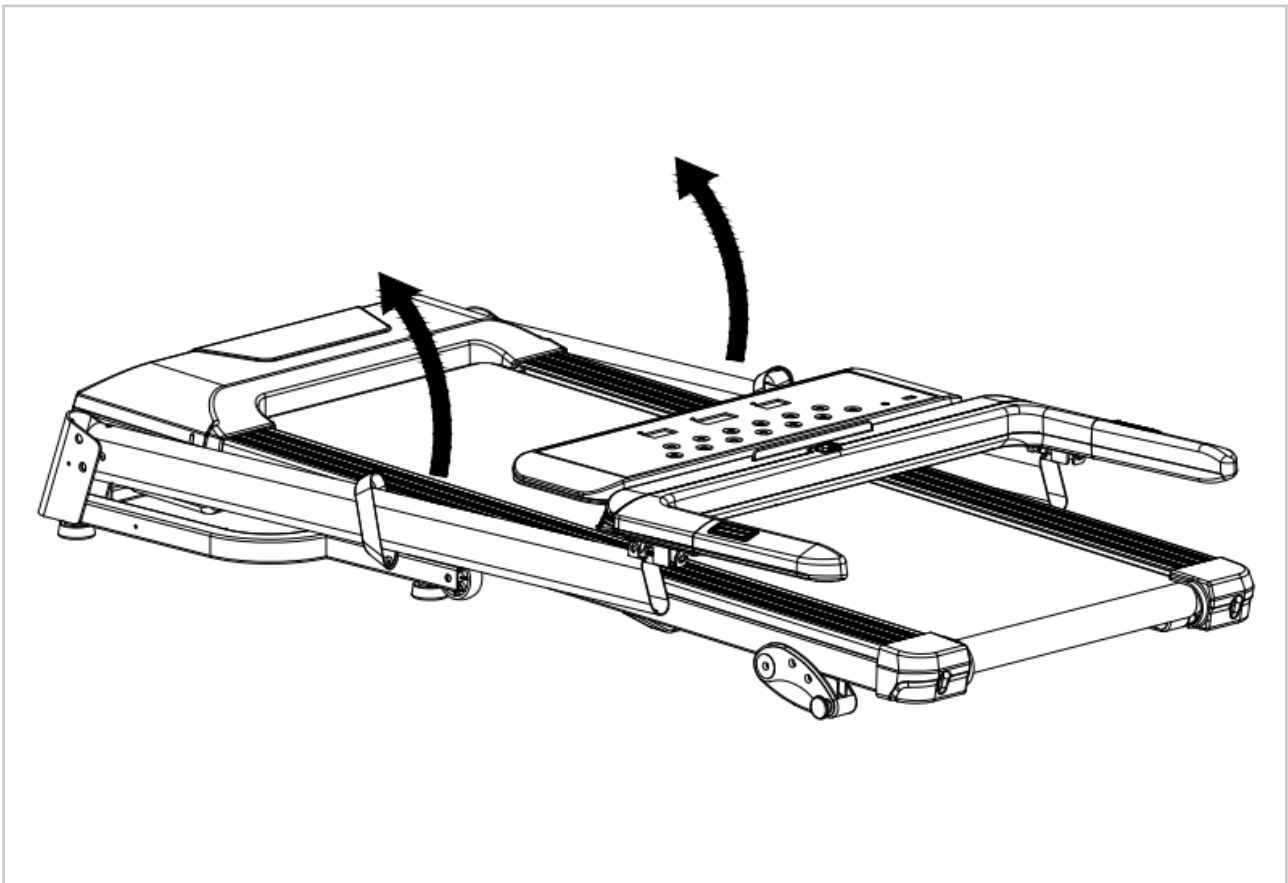

- Open the box, remove all parts from the box and place the main frame on a flat surface.
- Lift the uprights until they drop into the hinge of the main frame.

STEP 2

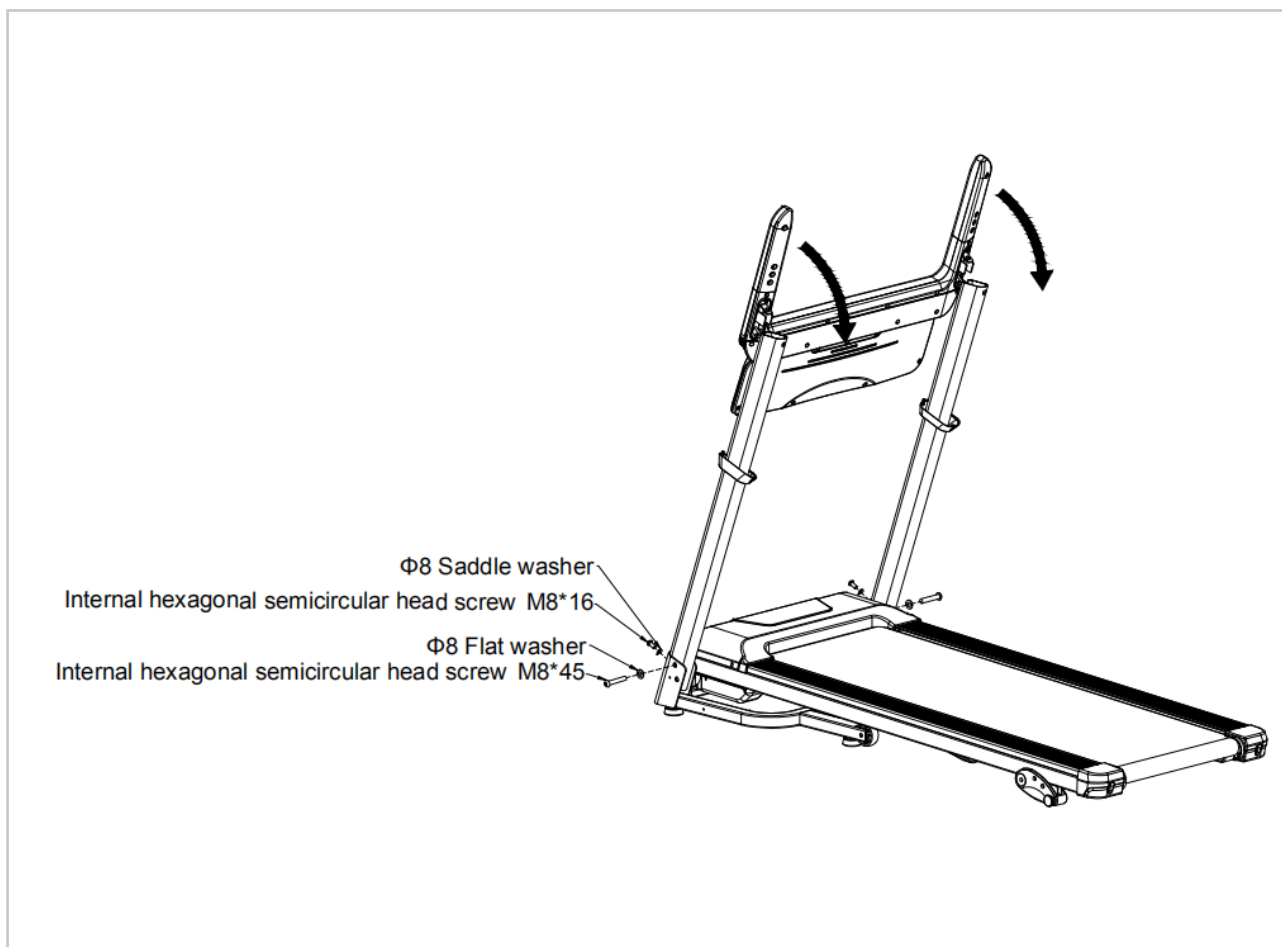

- Attach the uprights to the side with the screws and washers, then turn the panel in horizontal position.

STEP 3

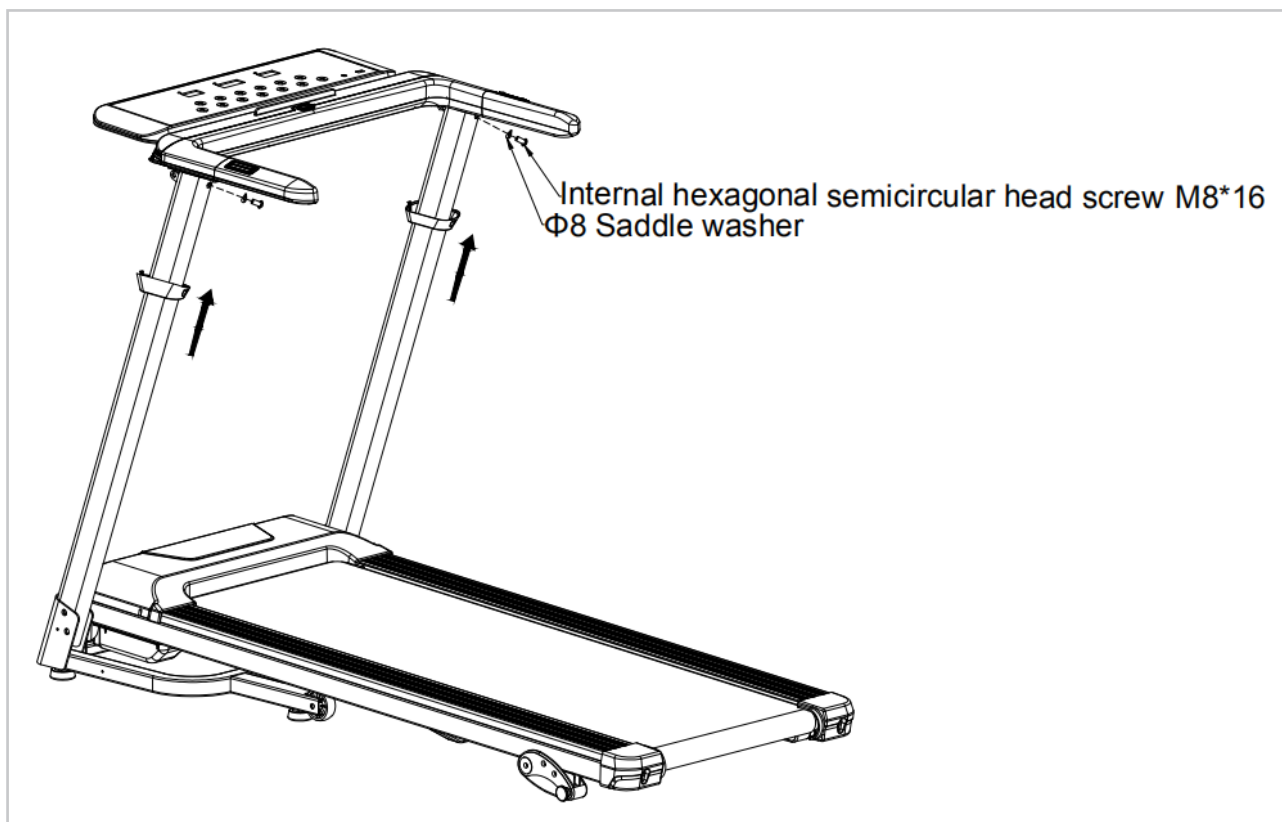

- Secure the console with the screws and washers.
- Slide the protective caps up.

STEP 4

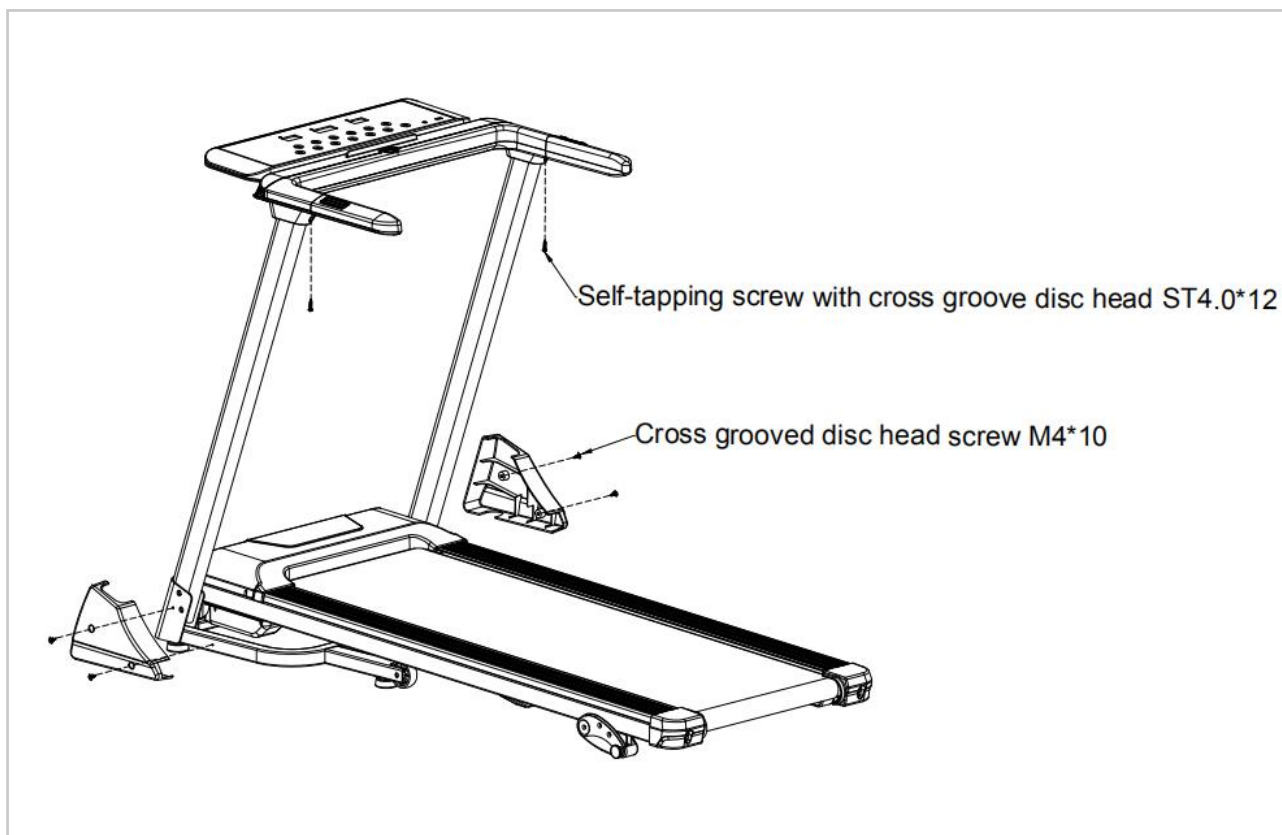

- Attach the protective caps as shown in the picture.

STEP 5



- Install the safety key in the console.
- When you start walking, attach the safety key to your clothes. Pull in an emergency on the safety cord of the key and the walking belt will stop immediately.
- Rotate the display window at a right angle. The treadmill is now ready for use. The switch is too located on the front of the treadmill.

NOTE!

- *When you use the treadmill, always go before the treadmill rolls on the rails. Once the belt rolls, you can stand on the walking platform. This way the engine is least loaded.*
- *After using the treadmill, turn off the power switch (on / off). In addition, use the emergency stop not unnecessary, only in an emergency. In this way, the circuit board is least loaded.*

NOTE! Store your machine in a dry area away from children and high traffic areas as shown in the illustration. Be sure it is secure and cannot fall onto small animals or children.

FOLDING

First, lift the back part of the frame board with your hand till you hear a light sound, which means the folding system has been locked. Running board can't be turned to the opposite direction now.

UNFOLDING

Place the folded treadmill in a spacious area. Lift the back part of the frame board with your hand, then click the spring to unfold the machine.

RUNNING BELT ADJUSTMENT

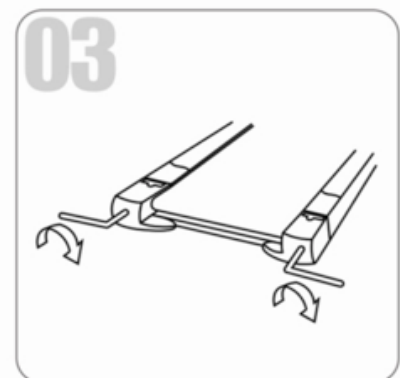
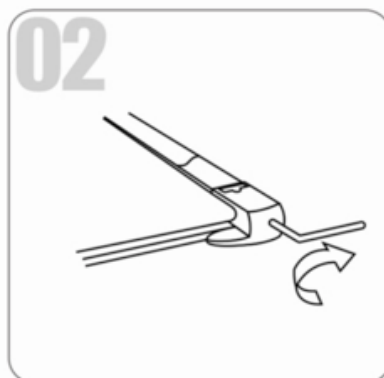
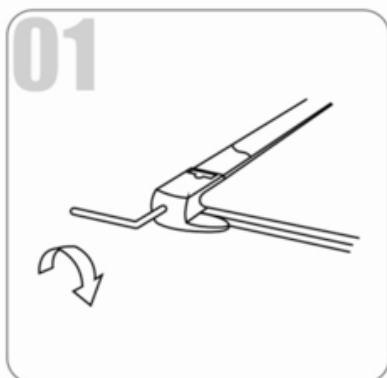

01. Running belt deviates to left

Start the machine, set speed at 2-3 km/h without a load on the belt, use Allen key to turn the screw 1/4 turn (see fig. 1). Then allow the machine to run without a load for 1-2 minutes. Repeat process until the belt becomes central.

02. Running belt deviate to right

Start the machine, set speed at 2-3 km/h without a load on the belt, use Allen key to turn the screw 1/4 turn (see fig. 2). Then allow the machine to run without a load for 1-2 minutes. Repeat process until the belt becomes central.

03. Running belt jam

If the running belt is in dead condition, use the Allen key to turn the screw 1/2 a turn both left and right until the jam solved (see fig 3).

Safe and effective use can only be achieved if the device will be assembled and maintained well. It is your responsibility to ensure that the equipment is regularly maintained. Parts that are already used and / or damaged must be replaced before continuing using. The rower machine may only be used indoors and stored away, prolonged exposure to weathering and changes in temperature / humidity can have a serious impact on the electrical components and moving parts of the device.

DAILY MAINTENANCE

- Clean and remove sweat after each use Do not use aggressive cleaning agents and ensure that the device remains free of moisture.
- Check that the rail and the wheels under the seat are free from dust and dirt.

SEMI-ANNUAL MAINTENANCE

- Inspect all bolts and nuts in connection with moving parts of the device, tighten as required.
- Check the mobility of moving parts and components of the use equipment, silicone spray if necessary.

CLEANING

WARNING

Before cleaning the machine, please make sure the power has been switched off.

Cleaning: General cleaning of the device will extend the life of the treadmill. Hold clean the treadmill by dusting regularly. Be sure to clean the exposed area of the belt and the foot rails of the treadmill on both sides.

In addition, wear clean shoes to reduce the risk of contamination of the treadmill. Remove the hood at least once a year to vacuum underneath.

LUBRICATING THE BELT

This treadmill is equipped with a pre-lubricated, low maintenance deck system. The belt/ deck friction may play a major role in the function and life of your treadmill, thus requiring periodic lubrication. We recommend a periodic inspection of the deck. You need contact with our service center if you find the damage of the deck.

We recommend lubrication of the deck according to the following timetable:

- **Light user** (less than 3 hours/ week) annually
- **Medium user** (3-5 hours/ week) every six months
- **Heavy user** (more than 5 hours/ week) every three months

Best indicator is to lubricate when the walking platform feels dry. We recommend that you buy the lubrication from our distributor or directly to our company.

NOTE: *Any repair need the professional technician.*

- We suggest that you should cut off the power for 10 minutes after keep running 2 hours, so that it's good for maintain the treadmill.
- For avoiding the slipping during running, the belt not too loose; for avoiding the more abrasion between the roller and belt and maintain the machine's good running ,the belt not too tight. You can adjust the distance between plates and belt, the belt be away from the plates about 50-75 mm on both sides, if the best not too tight and loose.

We strongly recommend that you do the following

- Switch off and remove the power cable from the wall after every use, especially if children are present.
- Clean your treadmill after use.
- Use a dry cloth to clean the control panel and areas around the power switch. Use a soft clean cloth and cleanser to remove stubborn stains and dirt off the running belt.
- Tighten the running belt once a month.
- Keep your treadmill in a safe dry place away from heat and water.

USAGE OF SILICONE OIL

Pull up tightly of the running belt. Then put the silicone oil to running board. Then start the machine to running 3 minutes without loading. It is better to maintain like this every 30 hours working of the machine. This can save lifetime of parts properly.

**We recommend that you do the following:**

- Disconnect the power cord after every use, especially when children are present.
- Clean the treadmill after use.
- Use a dry cloth to cover the control panel and areas around the on/off switch clean.
- Use a soft clean cloth and detergent to remove stubborn stains and dirt from the treadmill.
- Tighten the treadmill once a month.
- Keep your treadmill away from heat and water in a safe, dry place.

Regular maintenance prolongs the life of your treadmill and prevents injury!

This treadmill is designed in a way that in the event of an electrical fault, the machine will turn off automatically to prevent any injuries to the user and to prevent damage to the machine (i.e. motor).

When the treadmill behaves erratically, simply reset the treadmill by turning the power switch off, waiting for 1 minute then turning the power button back on.

ALARM SIGNALS

E02 Over voltage protection of motor

- Make the machine self-checking again.
- Change controller.

E03 Over current protection

- Clean the dust between running board and belt, then put some oil.
- If the running belt wear seriously, please change the running belt.

E04 Motor open circuit

- Check the check the connect wire of motor ,if the connect wire loose, please connect it again.
- The motor carbon brush wear, replace carbon brush or motor.

E05

EEPROM damage or access problems change the controller board.

E06 Communication error

- Check the connect wire between computer and controller board, if it loose or broken, please connect it again or change it.
- Change the incline motor.

E09 short-circuit protection

Change the controller board.

“---” Safety key not connected.

Insert the safety key.

No Power

- Check fuses (They are located on the controller under the motor cover).
- Check power outlet (Plug something else into the power outlet to ensure that the power outlet is working correctly).
- Check Power Cable (You may need to take it to an electrician).

CONSOLE

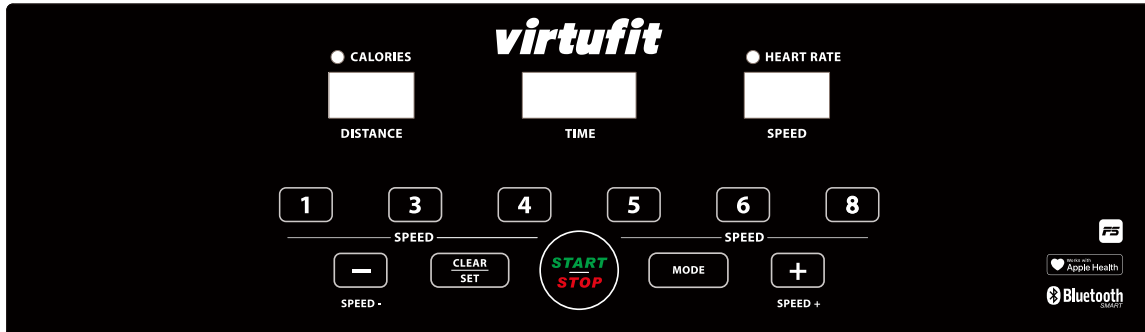

BUTTON	FUNCTION
(1) MODE	Turn on the machine, press the button to choose the preset programs P1-P15. Press CLEAR / SET to exit.
(2) START/ STOP	Turn on the machine, press the button to start walking. While walking, press the button to stop and register walking. Press CLEAR / SET to clear the registration.
(3) CLEAR/ SET	Turn on the machine, press the button to choose time, distance and calorie count-down training. While walking, the button can clear time, distance and calories.
(4) SPEED+	While walking, press the button to increase the speed by 0.5 km / h. Hold the button to increase speed continuously.
(5) SPEED -	While walking, press the button to decrease the speed by 0.5 km / h. Hold the button to decrease the speed continuously.
(6) QUICK SPEED	Speeds 2,4,6,8,10,12 can be selected during this run.

FUNCTIONS

BUTTON	FUNCTION
(7) SPEED + IN HANDRAIL	While walking, press the button to increase the speed by 0.5 km / h. Hold the button to increase speed continuously.
(8) SPEED - IN HANDRAIL	While walking, press the button to decrease the speed by 0.5 km / h. Hold the button to decrease the speed continuously.
(9) "START" LEFT HAND BAR	Has the same function as the "START" key.
(10) "STOP" RIGHT HAND BAR	Has the same function as the "STOP" key.
(11) "SPEED+" LEFT HAND BAR	Has the same function as the "SPEED +" key.
(12) "SPEED-" RIGHT HAND BAR	Has the same function as the "SPEED -" key.

SAFETY KEY

A safety key is supplied with this machine. Remove the safety key to stop the treadmill; the treadmill will turn off automatically. Inserting the safety key will reset the display.

FUNCTION DESCRIPTION

Power the treadmill on by plugging it into an appropriate wall outlet, then turn on the power switch located at the front of the treadmill below the motor shield. Ensure that the safety key is installed, as the treadmill will not power on without it. When the power is turned on, the display is ready for operation.

Press and release the START/STOP to begin belt movement, at 1.0 Km/h, then adjust to the desired speed using the '+' or '-'. You may also use the quick speed keys (2, 4, 6, 8, 10 and 12) to adjust the speed. You can also use 'speed +' or 'speed -' to adjust the speed on handrail.

- To slow the treadmill down, press and hold the 'speed -' key to desired speed. You may also press the rapid speed adjust keys: 2, 4, 6, 8, 10, 12.
- In a state of running, single press START/STOP, the walking belt will gradually slow down.
- In the state of running, single press CLEAR/SET will reset time, distance, calorie.

INCLINE FEATURE

When use the treadmill, you can select the different incline according to your favor.

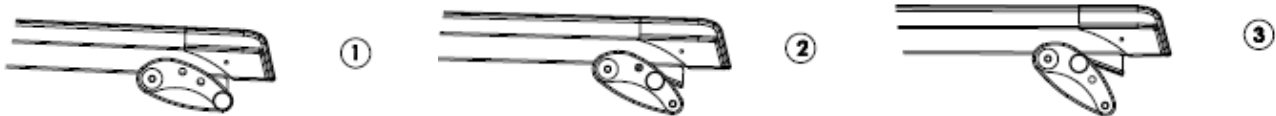

PULSE GRIP FEATURE

Hold on both stainless steel pulse sensors in the handrails, the The Pulse (Heart Rate) console window will display your current heart rate during the workout within 15 seconds .

NOTE! *You must use both stainless steel sensors to display your pulse.*

CALORIE WEERGAVE

Displays the cumulative calories burned at any given time during your workout.

NOTE! *This is only a rough guide used for comparison of different exercise sessions, which cannot be used for medical purposes.*

MODE

USER MANUAL MODE

Press "START" then the treadmill will run at a speed of 0.8km / h. All other screens count from 0. Press "-SPEED +" to adjust the speed..

MODE

- **Count-down training:** power on the machine, press CLEAR/SET to enter TIME count-down training, press it again to enter DISTANCE count-down training, press it once more to enter CALORIE count-down training. Finally press MODE to exit.
- **TIME count-down training:** power on the machine, press CLEAR/SET, TIME figure glittering, showing 30:00. Press SPEED+,- to choose the time between 5-99minutes. Press START/STOP to start at speed of 1.0km/h. Speed can be adjusted by pressing SPEED+,-. The machine stops when time shows 00:00.
- **DISTANCE count-down training:** power on the machine, press CLEAR/SET two times, distance figure glittering, showing 1.0km. Press SPEED+,- to choose the distance between 1.0-9.0km. Press START/STOP to start at speed of 1.0km/h.Speed can be adjusted by pressing SPEED+,-. The machine stops when distance shows 0.00.
- **CALORIE count-down training:** Power on the machine, press CLEAR/SET three times, calorie figure glittering, showing 50CAL. Press SPEED+,- to choose the calorie between 10-990CAL. Press START/STOP to start at speed of 1.0km/h.Speed can be adjusted by pressing SPEED+,-. The machine stops when calorie shows 0.

TO SELECT A PROGRAM

- Power on the machine, press 'MODE' to choose desired program, then press and release 'START/STOP' to begin the program with default values.
- The speed window will now be showing the preset speed of the selected program.
- After every one minute speed can be altered automatically according to the programs, and can be altered manually. 3 Seconds before the ending of program a buzzer will sound three times, then the running belt will come to a stop.

PROGRAMS

Each preset program has a maximum speed level that is displayed when a desired workout is chosen. The speed that the particular program will achieve will be displayed in the Speed window. Each program has various speed changes throughout.

1. WALKING AND JOGGING

P1 PRIMARY

TIME(mins)	1	2	3	4	5	6	7	8	9	10	11	12	13	14	15	16	17	18	19	20	21	22	23	24	25	26	27	28	29	30	30MINS
SPEED(Km/h)	1	2	2	2	2	3	3	3	3	3	3	3	3	3	3	3	3	3	3	3	3	3	3	3	3	2	2	2	1	1	STOP

P2 PRIMARY

TIME(mins)	1	2	3	4	5	6	7	8	9	10	11	12	13	14	15	16	17	18	19	20	21	22	23	24	25	26	27	28	29	30	30MINS
SPEED(Km/h)	1	3	3	3	3	4	4	4	4	4	4	4	4	4	4	4	4	4	4	4	4	4	4	4	4	2	2	2	1	1	STOP

P3 WALKING

TIME(mins)	1	2	3	4	5	6	7	8	9	10	11	12	13	14	15	16	17	18	19	20	21	22	23	24	25	26	27	28	29	30	30MINS
SPEED(Km/h)	1	3	3	3	3	4	4	4	4	4	4	4	4	4	4	4	4	4	4	4	5	5	5	5	5	3	3	3	3	3	STOP

P4 JOGGING

TIME(mins)	1	2	3	4	5	6	7	8	9	10	11	12	13	14	15	16	17	18	19	20	21	22	23	24	25	26	27	28	29	30	30MINS
SPEED(Km/h)	1	4	4	4	4	6	6	6	6	6	6	6	6	6	6	6	6	6	6	6	6	6	6	6	6	3	3	3	2	2	STOP

P5 Runner1(AGE45-50)

TIME(mins)	1	2	3	4	5	6	7	8	9	10	11	12	13	14	15	16	17	18	19	20	21	22	23	24	25	26	27	28	29	30	30MINS
SPEED(Km/h)	2	6	6	6	6	6	6	6	4	4	4	4	4	4	4	5	5	5	5	5	5	5	3	3	3	3	3	3	3	1	STOP

P6 Runner2(AGE40-45)

TIME(mins)	1	2	3	4	5	6	7	8	9	10	11	12	13	14	15	16	17	18	19	20	21	22	23	24	25	26	27	28	29	30	30MINS
SPEED(Km/h)	2	6	6	6	6	6	6	6	5	5	5	5	5	5	5	6	6	6	6	6	6	6	3	3	3	3	3	3	3	1	STOP

P7 Runner3 (AGE35-40)

TIME(mins)	1	2	3	4	5	6	7	8	9	10	11	12	13	14	15	16	17	18	19	20	21	22	23	24	25	26	27	28	29	30	30MINS
SPEED(Km/h)	3	6	6	6	6	6	6	6	7	7	7	7	7	7	7	6	6	6	6	6	6	6	3	3	3	3	3	3	3	1	STOP

2. RUNNER

P5 Runner1(AGE45-50)

TIME(mins)	1	2	3	4	5	6	7	8	9	10	11	12	13	14	15	16	17	18	19	20	21	22	23	24	25	26	27	28	29	30	30MINS
SPEED(Km/h)	2	6	6	6	6	6	6	6	4	4	4	4	4	4	4	5	5	5	5	5	5	5	3	3	3	3	3	3	3	1	STOP

P6 Runner2(AGE40-45)

TIME(mins)	1	2	3	4	5	6	7	8	9	10	11	12	13	14	15	16	17	18	19	20	21	22	23	24	25	26	27	28	29	30	30MINS
SPEED(Km/h)	2	6	6	6	6	6	6	6	5	5	5	5	5	5	5	6	6	6	6	6	6	6	3	3	3	3	3	3	3	1	STOP

P7 Runner3 (AGE35-40)

TIME(mins)	1	2	3	4	5	6	7	8	9	10	11	12	13	14	15	16	17	18	19	20	21	22	23	24	25	26	27	28	29	30	30MINS
SPEED(Km/h)	3	6	6	6	6	6	6	6	7	7	7	7	7	7	7	6	6	6	6	6	6	6	3	3	3	3	3	3	3	1	STOP

P8 Runner4(AGE30-35)

TIME(mins)	1	2	3	4	5	6	7	8	9	10	11	12	13	14	15	16	17	18	19	20	21	22	23	24	25	26	27	28	29	30	30MINS
SPEED(Km/h)	3	6	6	6	6	6	6	6	7	7	7	7	7	7	7	6	6	6	6	6	6	6	8	8	8	8	8	8	8	3	STOP

P9 Runner5(AGE25-30)

TIME(mins)	1	2	3	4	5	6	7	8	9	10	11	12	13	14	15	16	17	18	19	20	21	22	23	24	25	26	27	28	29	30	30MINS	
SPEED(Km/h)	3	6	6	6	6	6	6	6	6	6	6	6	6	6	6	9	9	9	9	9	9	9	9	4	4	4	4	4	4	4	1	STOP

3. SPORT- DISTANCE RUNNER

P10 Runner1(AGE18-25)

TIME(mins)	1	2	3	4	5	6	7	8	9	10	11	12	13	14	15	16	17	18	19	20	21	22	23	24	25	26	27	28	29	30	30MINS
SPEED(Km/h)	2	4	4	4	4	4	4	4	4	7	7	7	7	7	7	9	9	9	9	9	9	9	12	12	12	12	12	12	3	3	STOP

P11 Runner2(AGE18-25)

TIME(mins)	1	2	3	4	5	6	7	8	9	10	11	12	13	14	15	16	17	18	19	20	21	22	23	24	25	26	27	28	29	30	30MINS
SPEED(Km/h)	3	5	5	5	5	5	5	5	8	8	8	8	8	8	8	10	10	10	10	10	10	10	10	13	13	13	13	13	3	3	STOP

P12 Runner3(AGE18-25)

TIME(mins)	1	2	3	4	5	6	7	8	9	10	11	12	13	14	15	16	17	18	19	20	21	22	23	24	25	26	27	28	29	30	30MINS
SPEED(Km/h)	3	4	4	4	4	4	4	4	7	7	7	7	7	7	7	12	12	12	12	12	12	12	12	12	12	12	12	12	4	4	STOP

4. LADY EXERCISER

P13 Runner1(AGE55-60)

TIME(mins)	1	2	3	4	5	6	7	8	9	10	11	12	13	14	15	16	17	18	19	20	21	22	23	24	25	26	27	28	29	30	30MINS
SPEED(Km/h)	2	4	4	4	4	4	4	4	5	5	5	5	5	5	5	5	5	5	5	5	5	5	4	4	4	4	4	4	2	2	STOP

P14 Runner2(AGE50-55)

TIME(mins)	1	2	3	4	5	6	7	8	9	10	11	12	13	14	15	16	17	18	19	20	21	22	23	24	25	26	27	28	29	30	30MINS
SPEED(Km/h)	2	3	3	3	3	3	3	3	4	4	4	4	4	4	4	5	5	5	5	5	5	5	6	6	6	6	6	6	7	7	STOP

P15 Runner3(AGE45-50)

TIME(mins)	1	2	3	4	5	6	7	8	9	10	11	12	13	14	15	16	17	18	19	20	21	22	23	24	25	26	27	28	29	30	30MINS	
SPEED(Km/h)	2	4	4	4	4	4	4	4	6	6	6	6	6	6	6	8	8	8	8	8	8	8	8	7	7	7	7	7	7	5	5	STOP

EXAMPLE PROGRAMS

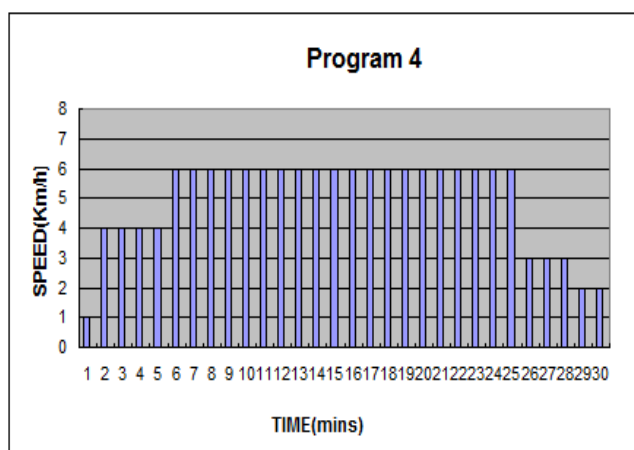
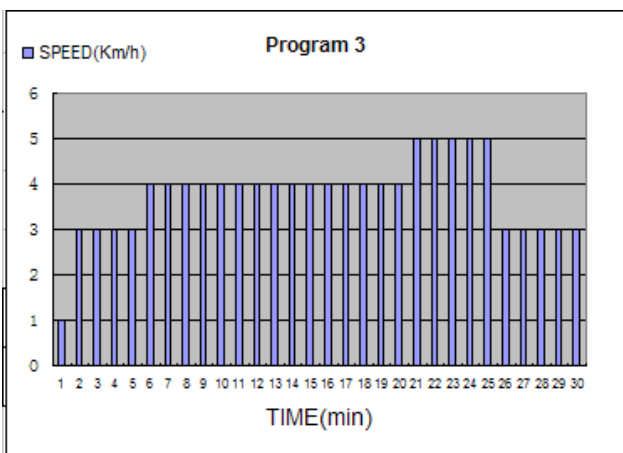
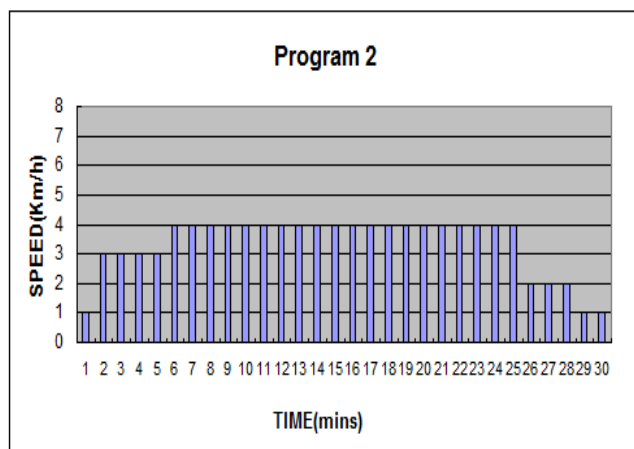
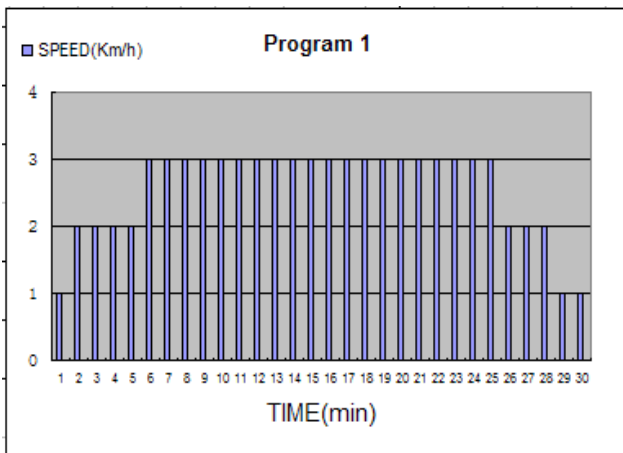

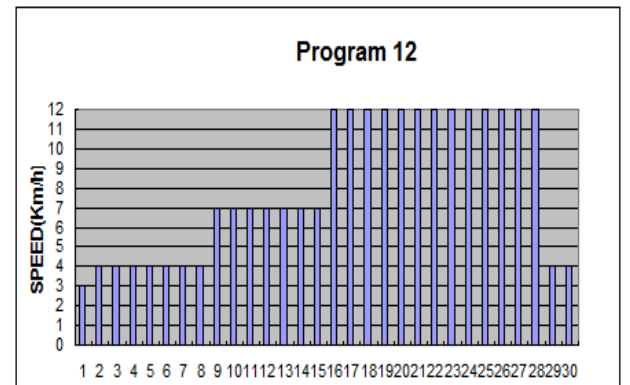
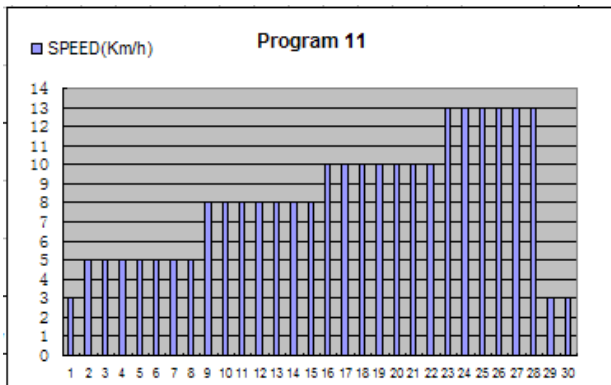
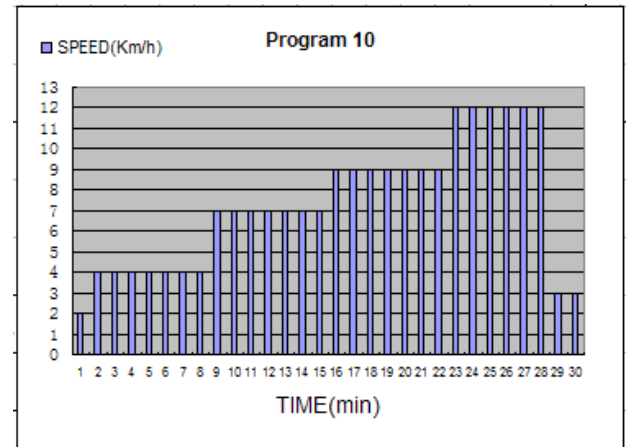
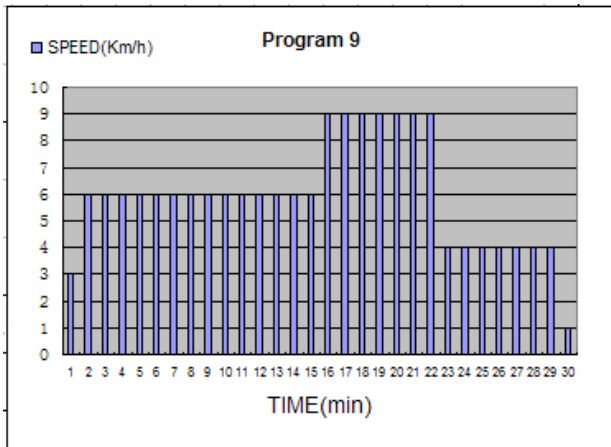
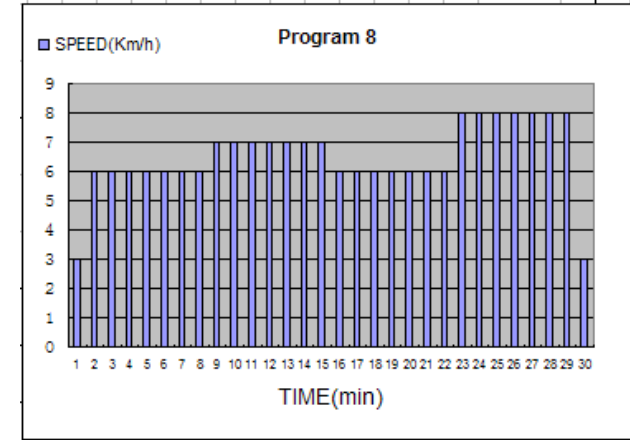
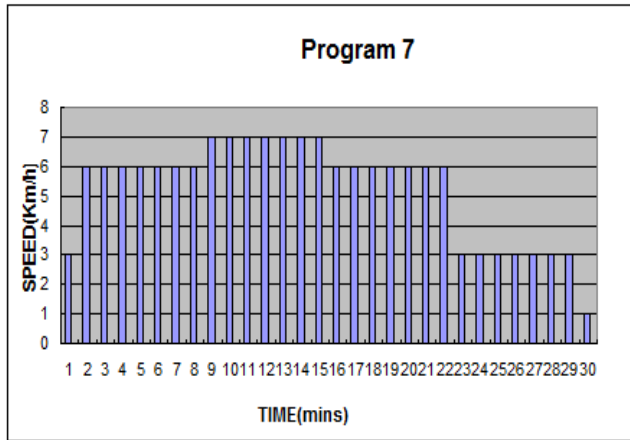
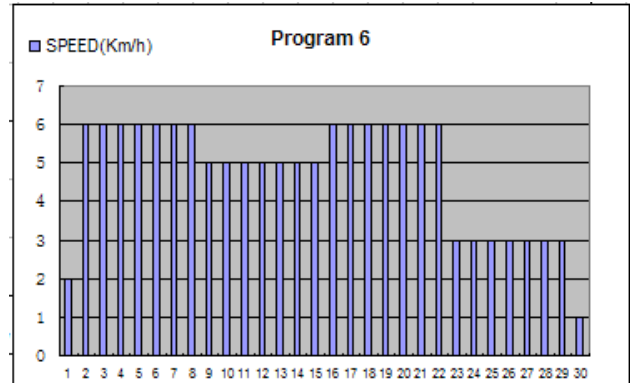
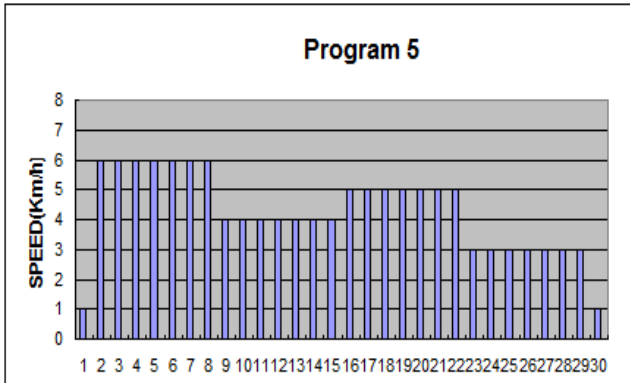

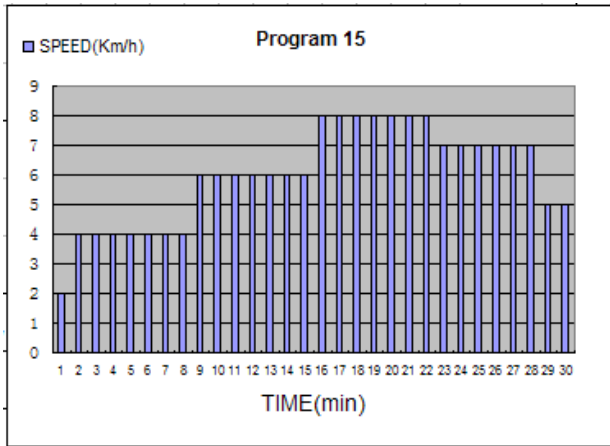
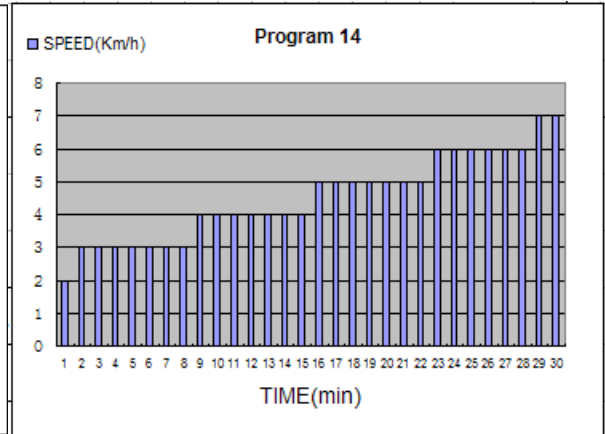
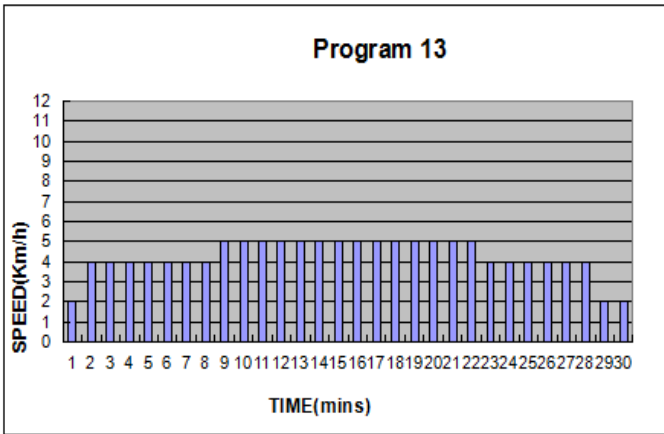

INSTRUCTION

1. QR code scanner app is required to scan the QR code with an Android or IOS phone or tablet. This app can be downloaded in the App Store or Google Play Store.
2. Scan one of the QR codes below to go directly to the place in the App Store or Google Play Store where the app is located and can be downloaded.
3. Scan the QR code on the right to go to the user manual of the app. The manual describes step by step how the app should be connected to the device, how the app works and what the options are.

FITSHOW

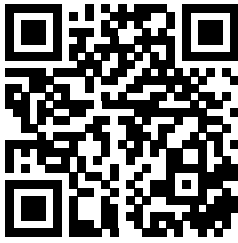

APP STORE
FITSHOW



GOOGLE PLAY
FITSHOW

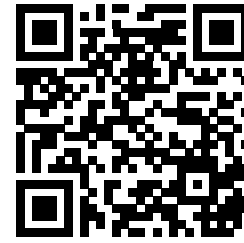

USER MANUAL
FITSHOW

VirtuFit does not provide service for third-party fitness apps such as Kinomap, iConsole, FitShow etc.. If you encounter any troubles with a third-party fitness app, please contact the app developer.

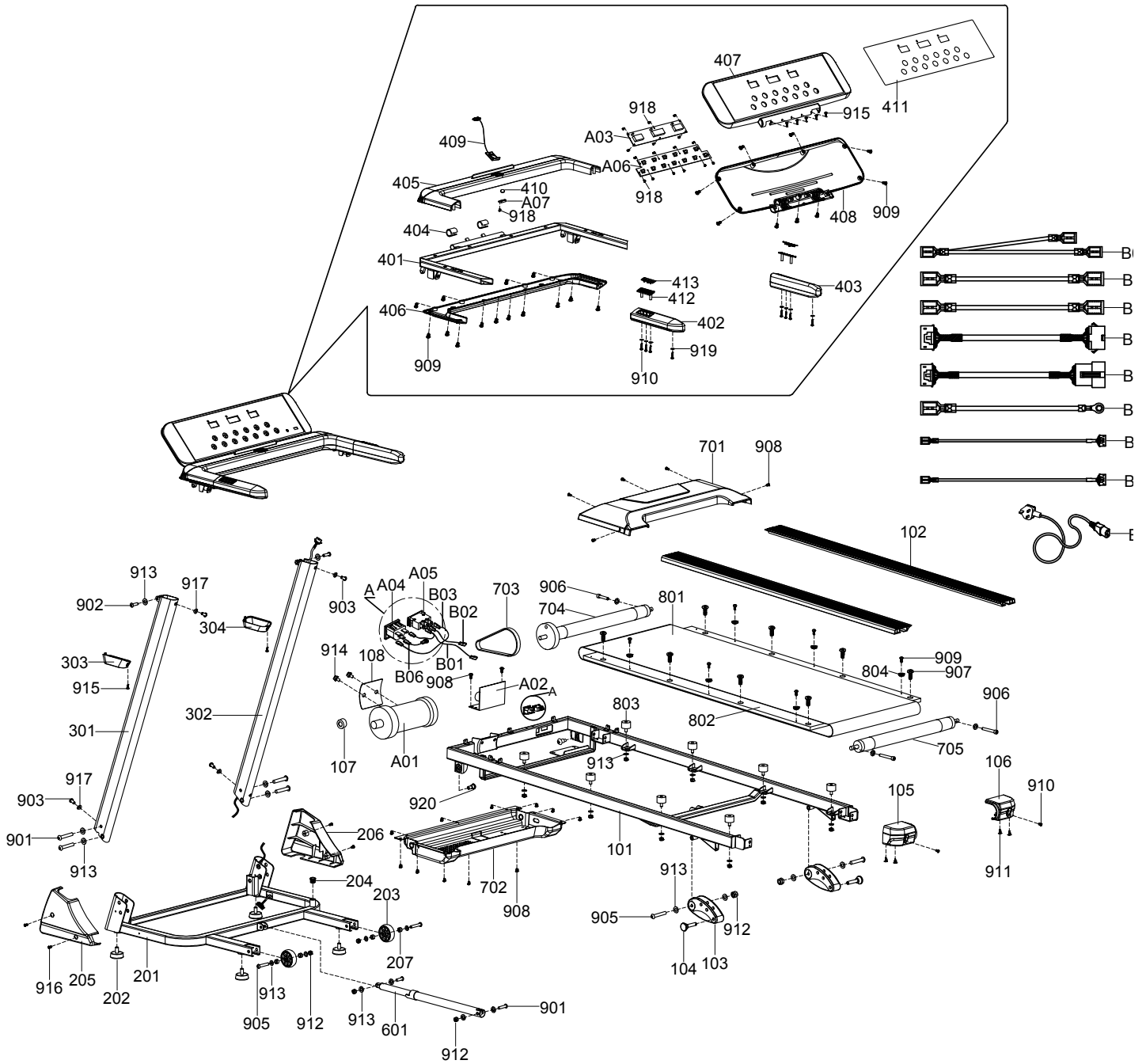

#	DESCRIPTION	QTY
101	Frame set	1
102	Siderail	2
103	back adjustment	2
104	back adjustment bolt	2
105	left end cap	1
106	right end cap	1
107	magnetic ring	1
108	Motor shock absorber pad	1
201	base frame set	1
202	adjustble pad	4
203	Φ60 moving wheel	2
204	Inner pipe plug	1
205	Left base decorative cover	1
206	Right base decorative cover	1
207	Limit sleeve	4
301	Left upright bar set	1
302	Right upright bar set	1
303	Left column decorative cover	1
304	right column decorative cover	1
401	console set	1
402	Left handrail cover	1
403	Right handrail cover	1
404	Console rotary shaft sleeve	2
405	upper cover of console	1
406	lower cover of console	1
407	upper cover of console center	1
408	lower cover of console center	1
409	Safety key	1
410	Magnetizer	1
411	Console sticker	1
412	Heart rate tablet fixer	2

#	DESCRIPTION	QTY
413	Handle heart rate piece	4
601	Gas spring	1
701	upper motor cover	1
702	Lower motor cover	1
703	Drive belt	1
704	Front roller	1
705	Back roller	1
801	Running belt	1
802	Running board	1
803	Spring cushion	8
804	Fixed buckle of siderail	6
901	Hexagon Socket Mushroom Cap	5
902	Hexagon Socket Mushroom Cap	2
903	Hexagon Socket Mushroom Cap	4
904	Hexagon Socket Mushroom Cap	1
905	Hexagon Socket Mushroom Cap	4
906	Inside hexagonal cylindrical head	3
907	Cross grooved countersunk head	8
908	Self-tapping screw large	16
909	Self-tapping screw cross groove	29
910	Self-tapping cross groove disc	2
911	Self-tapping self-drilling screw	4
912	Type 1 Hexagonal Locking Nut	14
913	Flat washer - Class C Φ8	24
914	Hexagonal anti-loosening bolt	2
915	Self-tapping screw with cross	7
916	Cross grooved disc head screw	4
917	Saddle washer Φ8	4
918	Cross grooved round head tap	17
919	Flat washer - Class C Φ5	8
920	Inside hexagonal step bolt	2

#	DESCRIPTION	QTY
A01	Motor	1
A02	Motor PCB	1
A03	Console	1
A04	Power socket	1
A05	Warping switch	1
A06	Keyboard	1
A07	Safety Switch Inductor	1
B01	AC input line (black)	1
B02	AC output line (red)	1
B03	AC input line (red)	1
B04	upright connect wire	1
B05	console connect wire	1
B06	Power Earth	1
B07	Heart rate wire	1
B08	Heart rate wire	1
B09	plug	1

A successful exercise program consists of a warm-up, aerobic exercise, and a cool-down. Do the entire program at least two and preferably three times a week, resting for a day between workouts. After several months, you can increase your workouts to four or five times per week.

WARMING UP

The purpose of warming up is to prepare your body for exercise and to minimize injuries. Warm up for two to five minutes before strength-training or aerobic exercising. Perform activities that raise your heart rate and warm the working muscles. Activities may include brisk walking, jogging, jumping jacks, jump rope, and running in place.

STRETCHEN

Stretching while your muscles are warm after a proper warm-up and again after your strength or aerobic training session is very important. Muscles stretch more easily at these times because of their elevated temperature, which greatly reduces the risk of injury. Stretches should be held for 15 to 30 seconds.

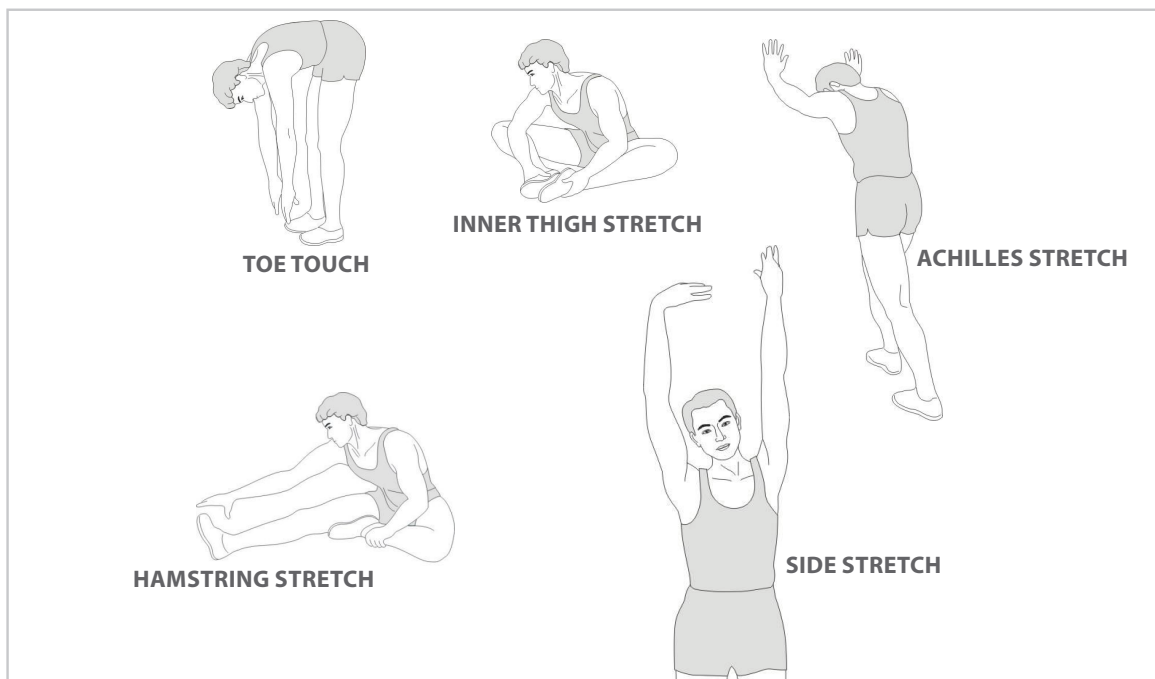

COOLING DOWN

The purpose of cooling down is to return the body to its normal or near normal, resting state at the end of each exercise session. A proper cool-down slowly lowers your heart rate and allows blood to return to the heart.

virtu profit

For questions or missing parts please contact your dealer.